



DOOR/REAR DECK SPEAKER  
HAUT-PARLEUR POUR PORTIÈRE/PLAGE ARRIÈRE

# KFC-1379ie

INSTALLATION INSTRUCTIONS  
PROCÉDURES D'INSTALLATION

Speaker locations  
Emplacement des haut-parleurs  
Plazierung der Lautsprecher  
Locatie van Luidsprekers  
Luogo di installazione degli altoparlanti  
Ubicación de los altavoces

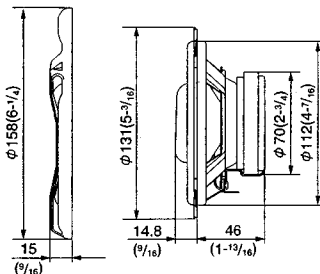
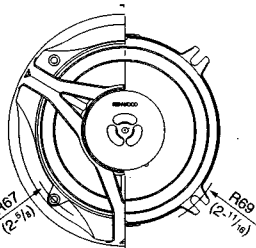
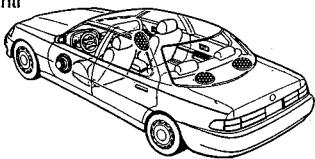

Dimensions  
Abmessungen  
Dimensioni

Dimensions  
Afmetingen  
Dimensiones

Unit: mm (inch)  
Unité: mm (pouces)

TEMPLATE GABARIT SCHABLONE SJABLOON MASCHERINA PLANTILLA

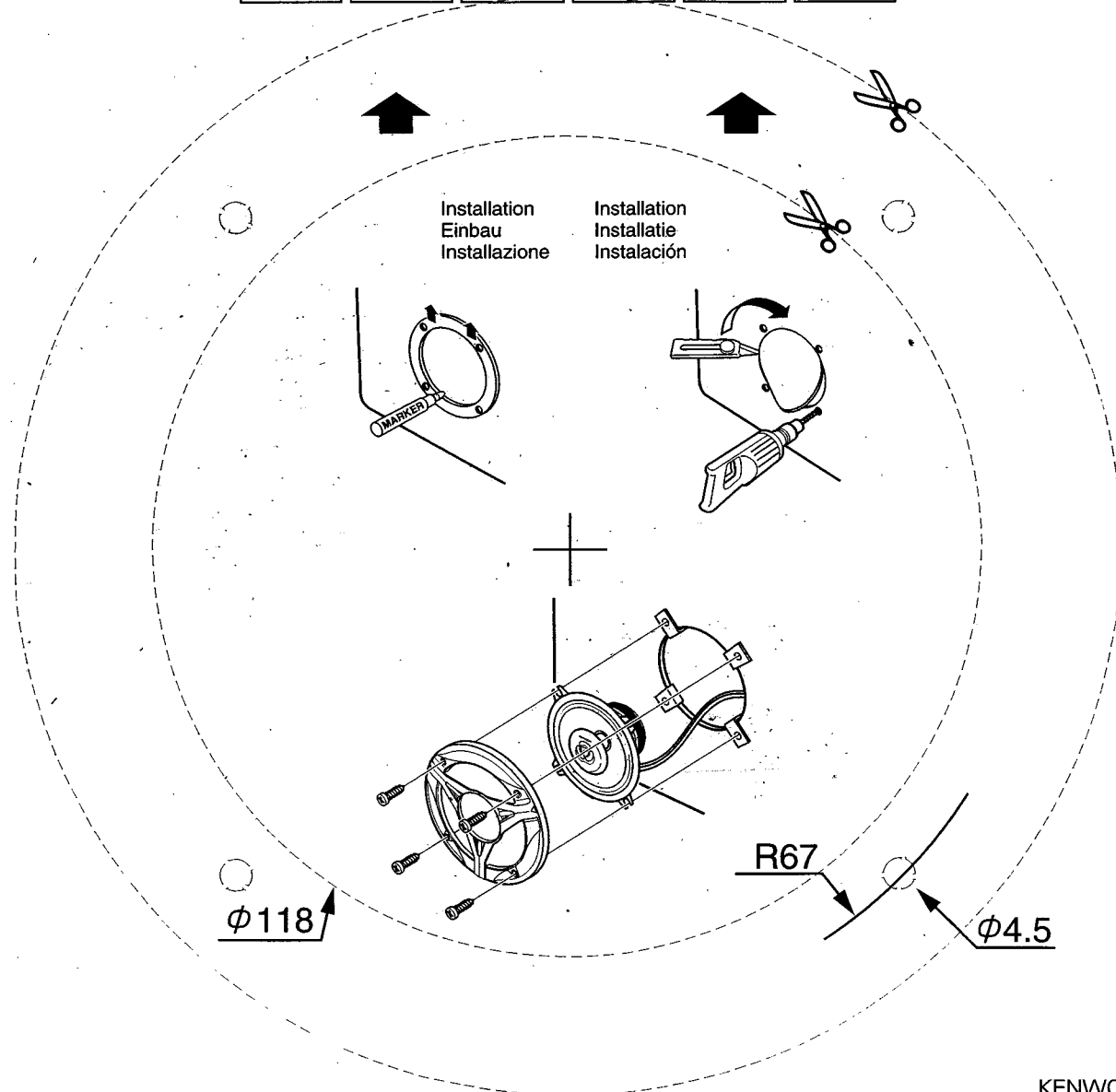

Connections  
Anschlüsse  
Collegamenti

Raccordements  
Aansluitingen  
Conexiones



Left  
Gauche  
Links  
Linker  
Sinistro  
Izquierdo

Right  
Droite  
Rechts  
Rechter  
Destro  
Derecho

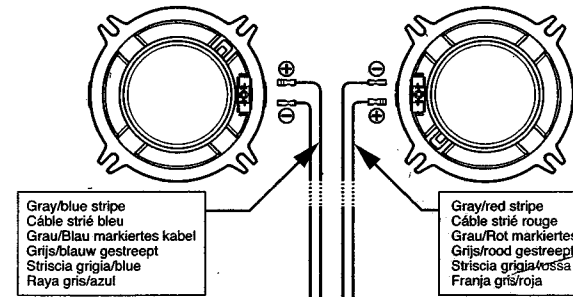

CAR AUDIO COMPONENTS  
ELEMENTS HI-FI POUR VOITURE  
AUTO STEREO-KOMPONENTEN  
AUTO STEREO-KOMPONENTEN  
COMPONENTI AUDIO PER AUTO  
COMPONENTES DE AUDIO PARA AUTOMÓVILES

Parts included  
Mitgeliefertes Zubehör  
Parti incluse

Pieces comprises  
Bijgeleverde onderdelen  
Partes incluidas

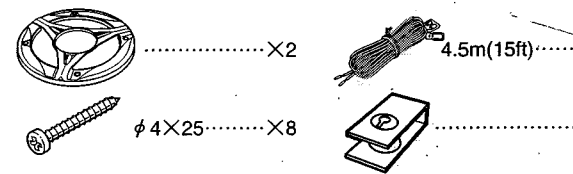

- Do not use the provided speaker cords for other purposes (such as a power cord). Otherwise malfunction or fire hazard could result.
- Ne pas utiliser les cordons de liaison aux enceintes pour une destination autre que celle prévue (par exemple, pour alimenter un appareil). Faute de quoi, un défaut de fonctionnement ou un incendie pourraient en résulter.
- Die mitgelieferten Lautsprecherkabel dürfen nicht für andere Zwecke verwendet werden (z.B. als Netzkabel), da dies eine Funktionsstörung oder die Gefahr eines Brandes verursacht.
- Gebruik de bijgeleverde luidsprekersnoeren niet voor andere doeleinden (bijvoorbeeld netsnoer), daar dat mogelijk brand of andere problemen veroorzaakt.
- Non utilizzare i cavi dei diffusori in dotazione per scopi diversi (come, ad esempio, di alimentazione). In caso contrario si possono causare incendi e folgorazioni.
- No utilice los cables de altavoces suministrados para otros propósitos (tales como lo un cable de alimentación). Si no, podrían producirse averías o peligros de incendio.

# IMPORTANT SAFEGUARDS

# KENWOOD

KENWOOD CORPORATION

**⚠ Caution : Read this page carefully to keep your safety.**

©PRINTED IN SINGAPORE B59-0467-00(W/FS) 017595  
90/12 11 10 9 8 7 6 5 4 3 2 1 88/12 11 10

Please read all of the safety and operating instructions before operating this unit. For best results, follow all warnings placed on the unit and adhere to the operating and use instructions. These safety and operating instructions should be retained for future reference.

**1. Suffocation** — After taking the unit out of the polyethylene bag, be sure to dispose of the polyethylene bag out of the reach of children. Otherwise, they may play with the bag, which could cause hazard of suffocation.

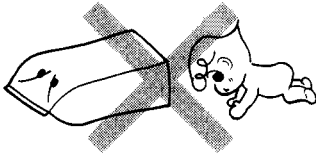

**2. Power supply voltage** — Connect the illumination lamp-equipped speakers to DC 12 V, negative ground.

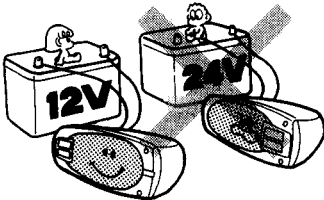

**3. Water and moisture** — Do not install the speakers in locations which may be subject to water or moisture.

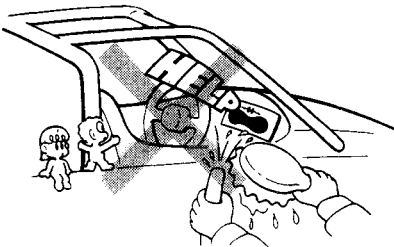

**4. Dust and unstable locations** — Do not install the speakers in unstable locations or locations subject to dust.

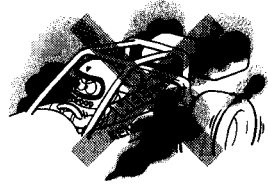

**5. Modification** — Do not attempt to open or modify the unit, for this could cause fire hazard or malfunction.

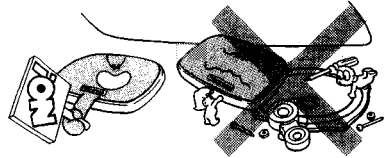

**6. Cleaning** — Do not use gasoline, naphtha, or any type of solvent to clean the speakers. Clean by wiping with a soft, dry cloth.

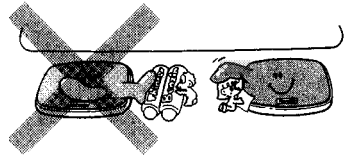

**7. Abnormal smell** — In the event the unit generates smoke or abnormal smell, immediately switch the power OFF. After this, please contact your dealer or nearest service station as soon as possible.

**POWER OFF!**

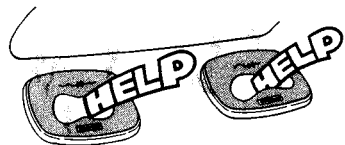

This warranty will be honored only in the U.S.A.

## **KENWOOD LIMITED WARRANTY FOR CAR STEREO COMPONENTS**

### **HOW LONG IS THE WARRANTY**

Kenwood U.S.A. Corporation ("Kenwood") warrants this product for a period of one (1) year from the date of original purchase.

### **WHAT IS COVERED AND WHAT IS NOT COVERED**

Except as specified below, this warranty covers all defects in material and workmanship in Kenwood car stereo components. The following are not covered by the warranty:

1. Any product which is not distributed in the U.S.A. by Kenwood or which is not purchased in the U.S.A. from an authorized Kenwood car stereo dealer or an automobile dealer, unless the product is purchased through the U.S.A. Military Exchange Service.
2. Any product on which the serial number has been defaced, modified or removed.
3. Damage, deterioration or malfunction resulting from:
  - a. Any shipment of the product (claims must be presented to the carrier).
  - b. Installation or removal of the product.
  - c. Accident, acts of nature, misuse, abuse, neglect, unauthorized product modification or failure to follow instructions supplied with the product.
  - d. Repair or attempted repair by anyone not authorized by Kenwood.
  - e. Any other cause which does not relate to a product defect.

### **WHO IS PROTECTED**

This warranty is enforceable only by the original purchaser.

### **WHAT WE WILL PAY FOR**

We will pay for all labor and material expenses for covered items. Payment of shipping charges is discussed in the next section of this warranty.

### **HOW TO OBTAIN WARRANTY SERVICE**

If your KENWOOD product ever needs service:

1. Take or ship it to any KENWOOD Authorized Service Center in the U.S.A. along with a complete description of the problem. (If you are uncertain as to whether a Service Center is authorized, please call 1-800-KENWOOD for the nearest Service Center. 1-800-536-9663).
2. Although you must pay any shipping charges if it is necessary to ship the product for warranty service, we will pay the return shipping charges if the repairs are covered by the warranty within the United States.
3. Whenever your units are taken or sent for warranty service, you must include a copy of the original dated sales receipt as proof of warranty coverage.

### **LIMITATION OF IMPLIED WARRANTIES**

ALL IMPLIED WARRANTIES, INCLUDING WARRANTIES OF MERCHANTABILITY AND FITNESS FOR A PARTICULAR PURPOSE, ARE LIMITED IN DURATION TO THE LENGTH OF THIS WARRANTY.

### **EXCLUSION OF DAMAGES**

KENWOOD'S LIABILITY FOR ANY DEFECTIVE PRODUCT IS LIMITED TO THE REPAIR OR REPLACEMENT OF THE PRODUCT AT OUR OPTION. KENWOOD SHALL NOT BE LIABLE FOR:

1. INSTALLATION OR REMOVAL CHARGES, DAMAGE TO OTHER PROPERTY CAUSED BY ANY DEFECTS IN KENWOOD CAR STEREO COMPONENTS, DAMAGES BASED UPON INCONVENIENCE, LOSS OF USE OF THE PRODUCT; OR
2. ANY OTHER DAMAGES, WHETHER INCIDENTAL, CONSEQUENTIAL OR OTHERWISE.

SOME STATES DO NOT ALLOW LIMITATIONS ON HOW LONG AN IMPLIED WARRANTY LASTS AND/OR DO NOT ALLOW THE EXCLUSION OR LIMITATION OF INCIDENTAL OR CONSEQUENTIAL DAMAGES, SO THE ABOVE LIMITATIONS AND EXCLUSIONS MAY NOT APPLY TO YOU.

This warranty gives you specific legal rights, and you may also have other rights which vary from state to state.

If a problem develops during or after the Limited Warranty Period, or if you have any questions regarding the operation of the product, you should contact your KENWOOD Authorized Dealer or Authorized Service Center. If the problem or your question is not handled to your satisfaction, please contact our Customer Relations Department at the address listed below: